

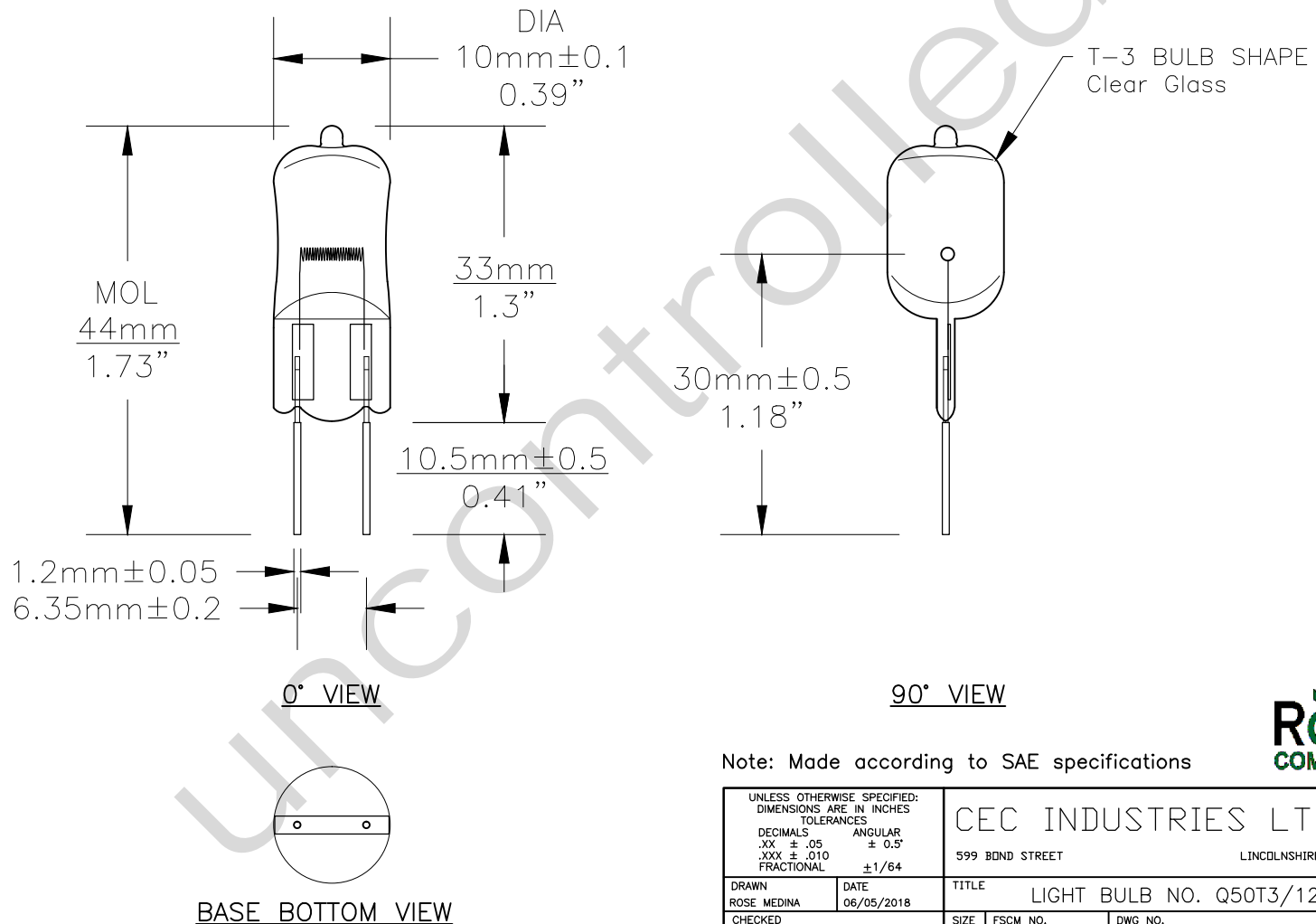

Since 1959

PART NO.	BASE TYPE	DESIGN VOLTS	DESIGN WATTS	LUMENS	FILAMENT TYPE	AVERAGE LIFE HOURS	REVISIONS			
							REV #	DESCRIPTION	DATE	APPROVED
Q50T3/12V/CL	GY6.35	12V	50W±10%	850±25%	C-6	2000	1	ISSUED	06/05/2018	R.M.



Note: Made according to SAE specifications



UNLESS OTHERWISE SPECIFIED: DIMENSIONS ARE IN INCHES TOLERANCES		CEC INDUSTRIES LTD			
DECIMALS	ANGULAR	599 BOND STREET		LINCOLNSHIRE, IL 60069	
.XX ± .05	± 0.5°				
.XXX ± .010					
FRACTIONAL	± 1/64				
DRAWN ROSE MEDINA	DATE 06/05/2018	TITLE LIGHT BULB NO. Q50T3/12V/CL			
CHECKED		SIZE A	FSCM NO.	DWG NO. Q50T3/12V/CL	REV 1
DESIGN		SCALE	PLOT SCALE	SHEET 1 OF 1	
MATERIAL		FILE Q50T3-12V-CL.pdf	DRAWING NOT TO SCALE		